

## Testmetode

Til påvisning af EMC immunitets robusthed.

www.delta.dk

We help ideas meet the real world



---

---

---

---

---

---

---

---

## Indhold

- Fejlmekanismer i elektroniske kredsløb som følger af elektrisk puls påvirkning
- Pulstyper og egenskaber
- Lidt om andres erfaringer
- Testudstyr

www.delta.dk

We help ideas meet the real world



---

---

---

---

---

---

---

---

## Forskellige halvleders følsomhed som funktion af energimængden

Følsomheds skala	Bliver påvirket	Halvleder typer	Brænder af
Mest følsom	$10E-7$ [J]	CMOS, MSI, LSI, IC	$10E-6$ [J]
	$10E-6$ [J]	HF transistorer	$10E-5$ [J]
	$10E-5$ [J]	Småsignal transistorer	$10E-4$ [J]
	$10E-4$ [J]	Småsignal dioder	$10E-3$ [J]
	$10E-3$ [J]		$10E-2$ [J]
	$10E-2$ [J]	Mellem effekt transistorer	$10E-1$ [J]
	$10E-1$ [J]	Ensuretter dioder	1 [J]
	1 [J]	Høj effekt transistorer	10 [J]
Mindest følsom	10 [J]	SCR, effekt dioder	100 [J]

www.delta.dk

We help ideas meet the real world



---

---

---

---

---

---

---

---



### Antenne virkningen ved $\lambda/4$

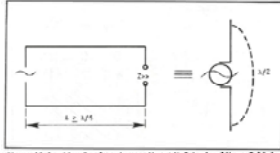
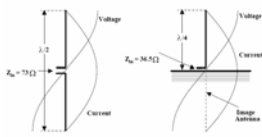

Figure 10.6 - Line Equal or Longer than  $\lambda/2$  Behaving Like a Filled  $\lambda/2$  Dipole



www.delta.dk



---

---

---

---

---

---

---

---

---

---

### Printbaner som antenner



www.delta.dk



---

---

---

---

---

---

---

---

---

---

### Følsomheden er afhængig af banernes fysiske dimensioner

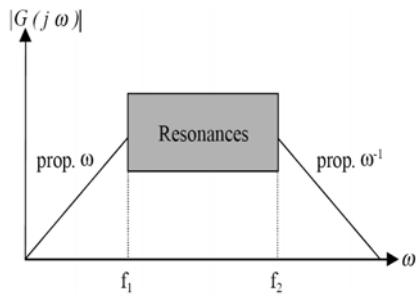

www.delta.dk



---

---

---

---

---

---

---

---

---

---

Uterminerede printbaner og kabler virker som resonatorer

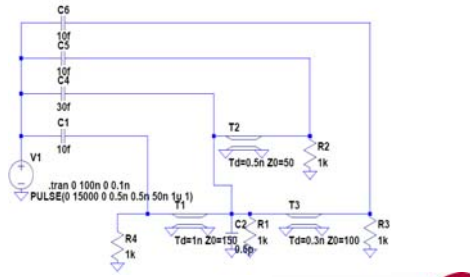

www.delta.dk

We help ideas meet the real world.



---

---

---

---

---

---

---

---

Som kan slås an af en elektrisk puls med højt frekvens indhold

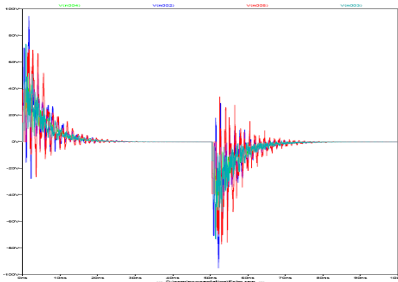

www.delta.dk



---

---

---

---

---

---

---

---

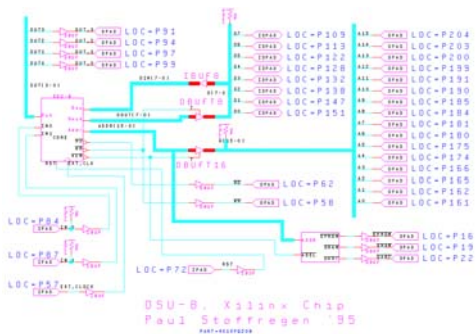

www.delta.dk

We help ideas meet the real world.



---

---

---

---

---

---

---

---

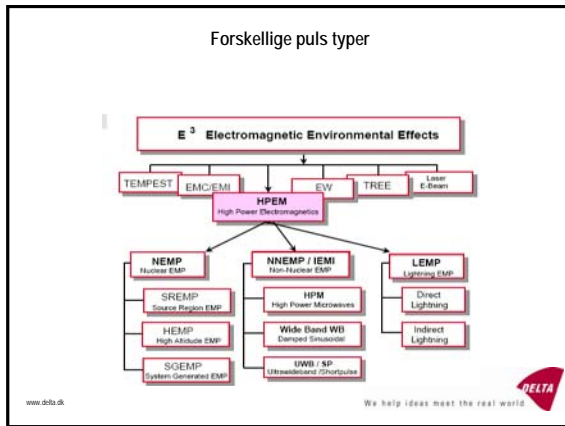

---

---

---

---

---

---

---

---

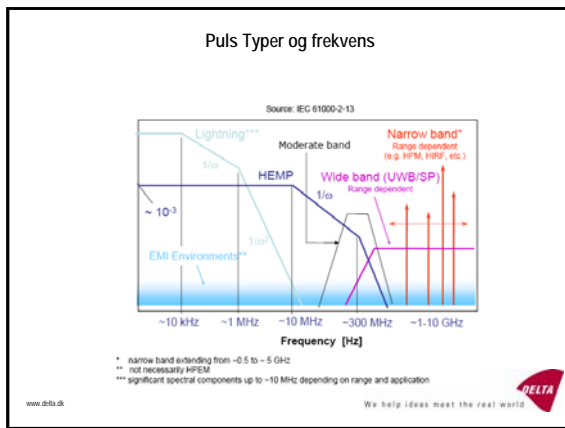

---

---

---

---

---

---

---

---

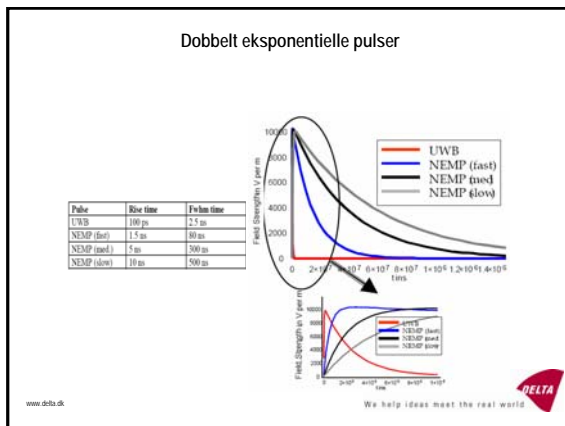

---

---

---

---

---

---

---

---

### Trapez formet puls tilnærmelser

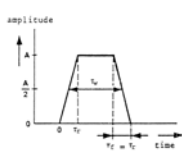

Fig. 3.6: Symmetrical impulse

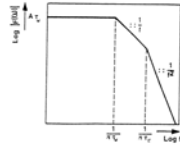
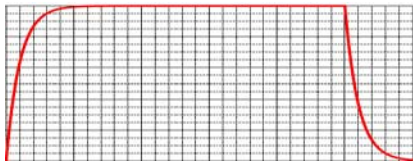

Fig. 3.7: Spectrum of a single impulse



www.delta.dk

DELTA real world

---

---

---

---

---

---

---

---

---

---

---

---

### Universel Pulse med eksponentiel stige og fald tid.

Tids / frekvens domæne repræsentation

$$V(t) = U(t) \cdot (1 - e^{-a \cdot t}) - U(t-dt) \cdot (1 - e^{-b \cdot (t-dt)})$$

$$\frac{\sqrt{(2a^2b - 2ab^2) \sin(dt \omega) + (-2ab \omega^2 - 2a^2b^2) \cos(dt \omega) + (b^2 + a^2) \omega^2 + 2a^2b^2}}{\sqrt{a^2 + (b^2 + a^2) \omega^2 + a^2 b^2 \omega^4}}$$

For a = b fås 
$$\frac{\sqrt{2} |a| \sqrt{1 - \cos(dt \omega)}}{\sqrt{\omega^2 + a^2} |\omega|}$$

www.delta.dk

We help ideas meet the real world



---

---

---

---

---

---

---

---

---

---

---

---

### Spektrrets hjørne frekvenser

Puls Form	DC spektral tæthed	Hjørne frekvens for -20 dB / dec.	Hjørne frekvens for -40 dB / dec.
Symmetrisk trapez pulse	$A \cdot \tau_w$	$\frac{1}{\pi \cdot \tau_w}$	$\frac{1}{\pi \cdot \tau_w}$
Dobbelt eksponentiel puls med ens stig og faldtid. $\tau$ er 50 % stige / faldtid.	$A \cdot \tau_w$	$\frac{1}{2,24 \cdot \tau_w}$	$Freq = \frac{-\ln(0.5)}{2 \cdot \pi \cdot \tau}$ $Niveau = \frac{A \cdot \tau}{-\ln(0.5)}$

www.delta.dk

We help ideas meet the real world



---

---

---

---

---

---

---

---

---

---

---

---

Spektrum af 0.3/0.3 ns og 0.3/50/0.3 ns eksponentiel puls

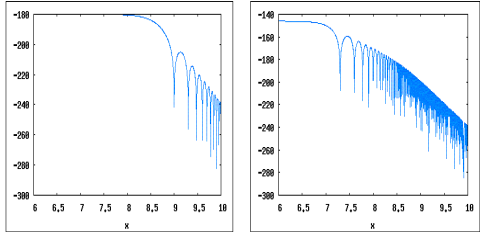

www.delta.dk

We help ideas meet the real world



---

---

---

---

---

---

---

---

---

---

---

---

Resultat af feltbæret forsøg på tyske universiteter.

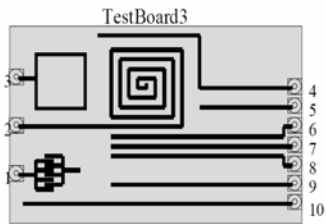

Fig. 6: Connector numbering test

www.delta.dk

We help ideas meet the real world



---

---

---

---

---

---

---

---

---

---

---

---

Maximum of the coupled energy at 10 kV/m

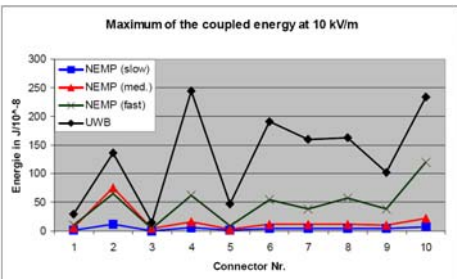

www.delta.dk

We help ideas meet the real world



---

---

---

---

---

---

---

---

---

---

---

---

### Puls flankestjålhedens betydning for fejlraten

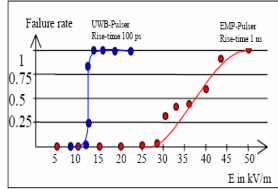

Fig. 10: Failure rate of a Rocky-518 HV board with a Pentium MMX CPU 233 MHz at different rise times

www.delta.dk

We help ideas meet the real world



---

---

---

---

---

---

---

---

---

---

### Simpel smalbands HPM generator



www.delta.dk

We help ideas meet the real world



---

---

---

---

---

---

---

---

---

---

### Mere sofistikeret udstyr til generering af UWB pulser

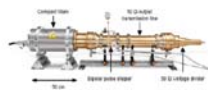

Fig. 1 - The 340 kV Marx generator with the bipolar pulse former connected to a 50 wideband voltage divider during characterization experiments.

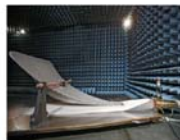

Fig. 2 - The half TEM horn antenna of the GEMIL on its 2.5 m long ground plane.

www.delta.dk

We help ideas meet the real world



---

---

---

---

---

---

---

---

---

---

1KV Solar Electronics Company  
Model 9355-1 trapez generator



www.delta.dk

We help ideas meet the real world



---

---

---

---

---

---

---

---

Workbench modificeret med stripline og skærmvindue

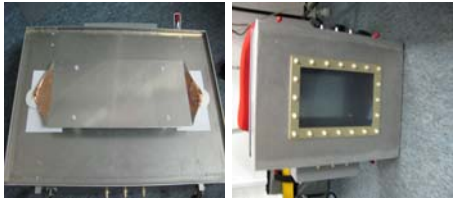

www.delta.dk

We help ideas meet the real world



---

---

---

---

---

---

---

---

Model 9355-1 trapez generator

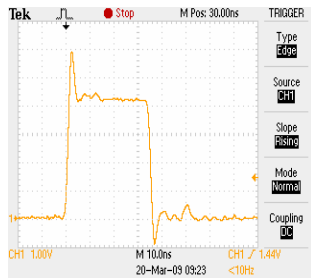

www.delta.dk

We help ideas meet the real world



---

---

---

---

---

---

---

---

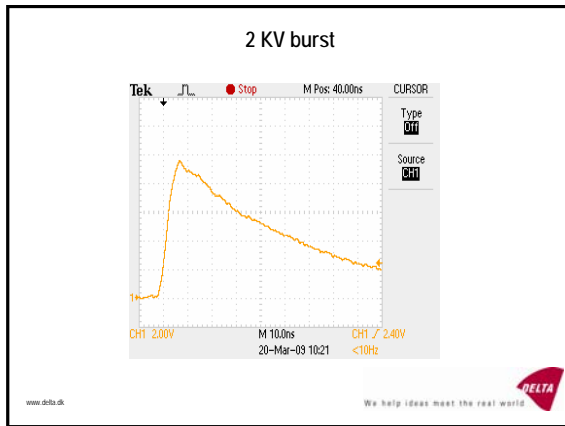

---

---

---

---

---

---

---

---

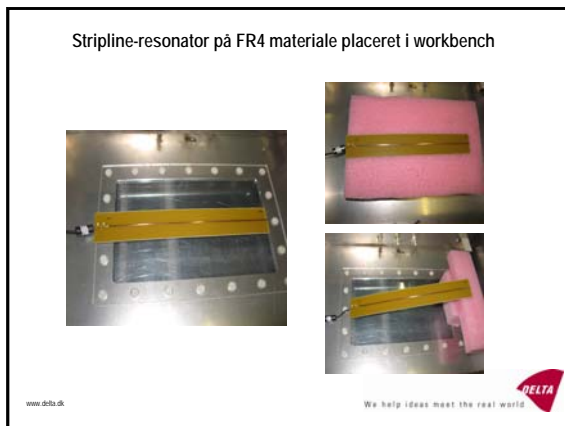

---

---

---

---

---

---

---

---

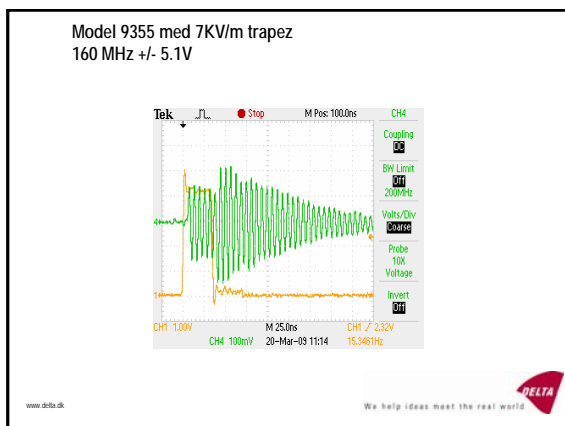

---

---

---

---

---

---

---

---

SLUT

www.delta.dk

We help ideas meet the real world.



---

---

---

---

---

---

---

---